

TDS21 WIFI HEATING THERMOSTAT



I. Product Summary:

TDS21 WiFi Heating Thermostat is WiFi touch screen thermostat with phone control. It is applied to temperature control of industrial, commercial and domestic room, and start of control heating appliances, especially floor heating systems. It can be controlled by phone. Phone systems are IOS and Android system optional.

II. Technical Parameter:

Power Supply	200 ~ 240V 50 ~ 60Hz
Current Load	≤3A (water heating) ≤16A (electric heating)
Power Consumption	<0.3W
External Material	PC+ABS (flame retardant)
Sensing Element	NTC
Set Temp. Range	5-60°C
Floor Set Temp. Range	5-99°C
Accuracy	±1°C
Dimension	86x86x13.3mm
Ambient Temp.	0-45°C, 5-95%RH (Non-condensing)
Storage Temp.	-5~55°C
Timing Error	<1%

III. Main Functions and Characteristics

1. WIFI for Android & Apple iOS
2. Large screen display and touch button
3. Power-off memory function
4. Real-time data save function
5. 5+2 or 6+1 or 7 days six periods program schedule
6. Anti-freezing function
7. 3 sensor modes can be setting
8. Selectable 80mmx80mm European hidden box.
9. With child lock function

IV. User Interface Explanation (Thermostat Port)

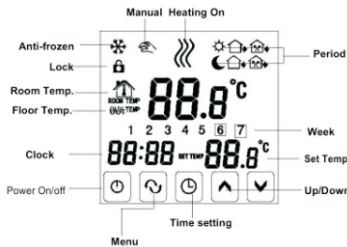

V. User Interface Explanation (Phone Port)

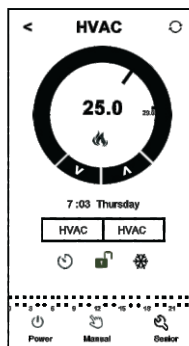

VI. Model Spec

Model	Current Loading	External Sensor	Week Program	Controlled Objects
TDS21WIFI-EP	16A	✓	✓	For electric heating appliances
TDS21WIFI-WP	3A		✓	For water heating appliances
TDS21WIFI-WPB	3A		✓	For gas boiler

VII. Wiring Diagram

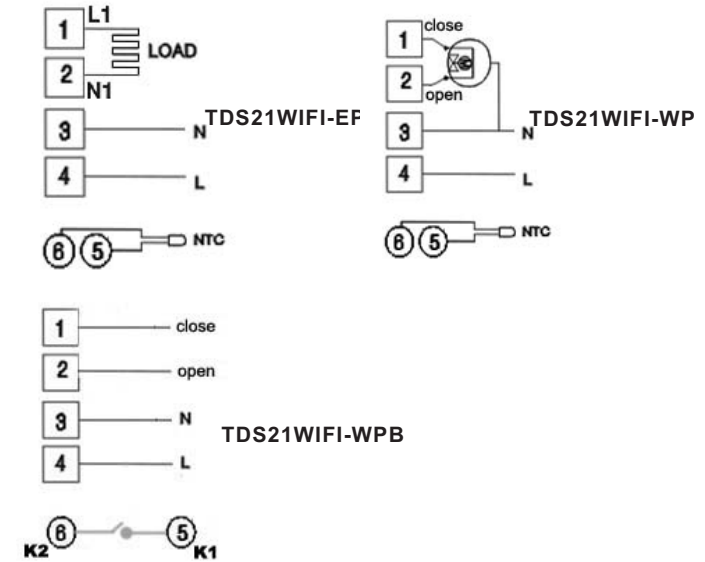

VIII. Thermostat Operation Instruction

1. Setting Power on/off

Press to turn on/off the power.

2. Setting Temperature

Press to set the temperature.

3. Setting the Clock

Press to set minute, hour and week.

Press for adjusting.

4. Setting the Manual Mode.

Manual mode means non-programmable mode.

Press then will display in the screen, it is in manual mode.

Press to set the temperature.

Press to set minute, hour and week.

5. Setting the Child Lock

Long press to enter into child lock mode, will display.

Long press again, the child lock will be disappeared.

6. Setting the Programmable Mode.

Press and hold into programmable mode. LOOP and 12345 will display.

Press to select the control way: 5+2 or 6+1 or 7 days programmable.

12345 display in the position of week means 5+2;

123456 display in the position of week means 6+1;

1234567 display in the position of week means 7 days programmable.

Press to select the periods.

Press to change the temperature;

Press to do time adjustment.

Press to change the time;

Press again to select the weekend's temp.

If you want to make temporary adjustment in any period, press then will flash. When finish the setting, all will confirm automatically.

Press to switch operation between manual mode and programmable mode.

Period	Period Icon	Defaulted Time	Defaulted Temp.	
Week	1		6:00	20°C
	2		8:00	15°C
	3		11:30	15°C
	4		12:30	15°C
	5		17:30	22°C
	6		22:00	15°C
Weekend	1		8:00	22°C
	2		23:00	15°C

Remark:

- (1) The defaulted temperature of period3 and period4 is the same as period2. Please change it according to the request.
- (2) When setting temperature is 00, this period is power off.
- (3) How to check floor temp?
During power on, press and hold then press the button of power to check floor temp.. OUT TEMP will display.
Press again to display room temp..

7. Advanced Setting

In the state of power-off, long press and hold then press into advanced setting mode. Then press to set relative item.

Display Code	Function	Setting And Options	Factory Default
SEN	Sensor mode	0:Internal sensor 1:Floor sensor 2:Both internal sensor and floor sensor	0
OSV	Set temp. range for floor sensor	5-99°C	42°C
DIF	Precision for floor temp.	1-9°C	2°C
SVH	High limit temp. for internal sensor	5-99°C	35°C
SVL	Low limit temp. for internal sensor	5-99°C	5°C
ADJ	Measure temp.	Check and calibrate the actual room temp.	0.5°Caccuracy calibrate
FRE	Anti-frozen	00 : Close anti-frozen 01 : Open anti-frozen	00
PON	Power memory	00 : Power memory off 01 : Power memory on	00
DFI	Precision for room temp.	0.5~3°C	1°C
FAC	Factory setting	10 or 32:Wifi mode open 08 : Just display	08

Remark:

Deadzone for floor temp.: i.e. the setting deadzone for floor sensor is 2, OSV is 42°C, when actual temp. reach 44°C, the relay will stop working; when actual temp. is back to 40°C, the relay starts working again. It works when room temp. is lower than set temp.

Sensor error:

Please select the right sensor mode. If select the different mode or there is error of sensor, Err will display on the LCD screen, the thermostat will stop heating till the problem is solved.

IX. Phone Port Operation Instruction

1. Install APP on phone

For iOS system: Login in App Store, search “Beok Home”, you can download it on your iphone.

Or scan below code to download:



For Android System: Login in Google Play, search “Beok Home”, you can download it on your phone.

Or scan below code to download:



2. Connection Thermostat with Phone

Thermostat Setting

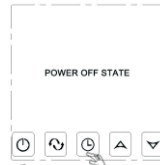

Hold on Clock key, then press Power key.

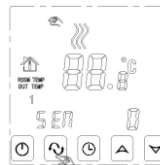

Go into Advanced Setting, press Menu key 9 times until FAC mode appears.

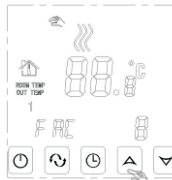

When FAC appears, press UP key to change from 8 to 10 or 32.

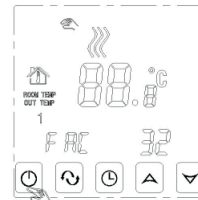

Then, press power off.

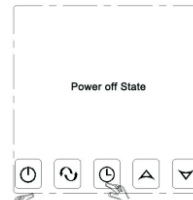

Hold on Clock key, then press Power key again.

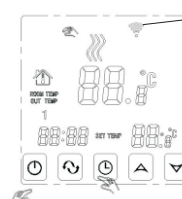

Twinkling Quickly and Frequently: Connection can start

Twinkling slowly: Off Line

Twinkling Stops: Successful Connection

At this time, wifi symbol will be twinkling quickly and frequently. It means, you can connect thermostat with phone now.

When wifi symbol stop twinkling, it means thermostat is successfully connected with phone.

Connection with Phone

Open Beok Home APP on your phone, you can see APP welcome page

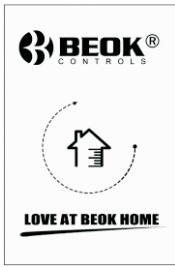

When the thermostat Wifi Symbol twinkling fast, you can start the configure on your Phone.

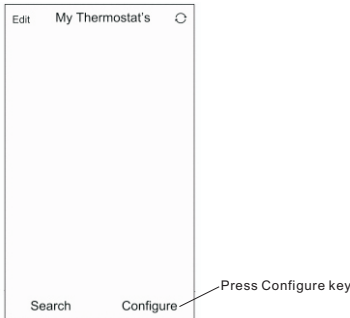

Enter your wifi name and password, then start connection at below. When connection success, it will appear "Connection Success".



After connection success, you need press "Search " key.

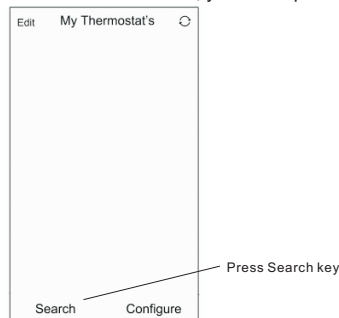

Then it will appear your wifi thermostat HVAC. HVAC is the factory setting name, when you have more than 2 thermostats, you can change it to any name you want.



- Long press HVAC for 5 seconds, it will appear Edit Thermostat page.
- Press Modify Current Thermostat.
- You can change HVAC to room 1, Bedroom Bath room, or anything you like.

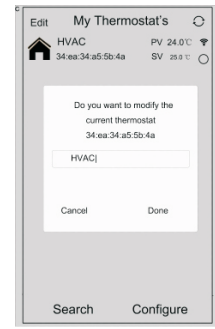
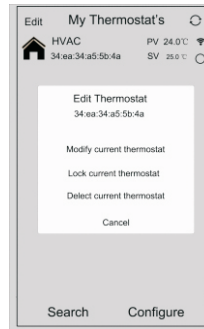

APP Interface on the Phone

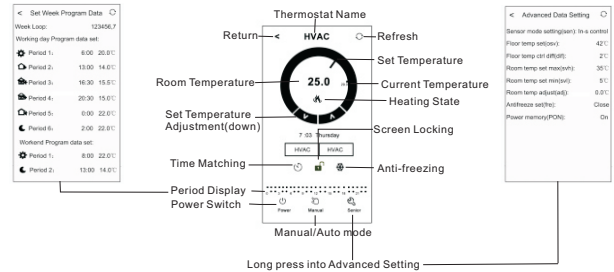

Thermostat Setting through Phone Operation

- Clock :** You can press Time Matching switch to match your phone clock with thermostat clock.
- Children lock (screen locking) :** Press to lock the thermostat.
- Anti-Freezing:** Press thermostat will show on the screen , it means Anti-freezing function open.
- Temperature setting:** You can directly drag the pointer on Temperature Setting Dial to set temperature. Or press and to set temperature step.
- Period setting:** Long press Period Display then you will go into the Period Setting mode:

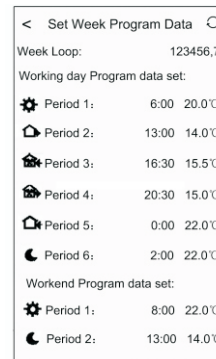

Touch work loop: you can choose the week program mode: 5+2/ 6+1 /7. Touch each time value: you can set the time of the period. Touch each temperature: you can set the temperature of the period. Notice: When you choose the program mode to 7, Weekend program data set will no appear.

- Advanced Setting:** Long Press Senior , you will go into Advanced setting mode:

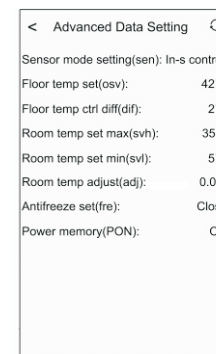

Display Code	Function	Setting And Options	Factory Default
SEN	Sensor mode	In-s control Out-s control In-s control., Out-s limit	In-s control
OSV	Floor set temp. range	5-99℃	42℃
DIF	Floor temp. ctrl diff	1-9℃	2℃
SVH	Room temp set max	5-99℃	35℃
SVL	Room temp set min	5-99℃	5℃
ADJ	Room temp. adjust	-5-5℃	0℃
FRE	Anti-frozen	close/open	Close
PON	Power memory	off/on	On

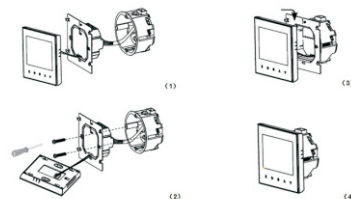

1. Connect the line of power and valve into the terminals. Fix the wall plate into the wall box by a screwdriver.
2. Connect the lines with the LCD board.
3. Connect the LCD board into the wall plate.

NOTICE: The installation wire should be 1.5-2.5mm².

XII. ATT:

Thank you for buying this product!

Please read this manual for complete instructions on installing and operating your thermostat. If you require further assistance, please feel free to contact us.

In the box you will find:

Model	TDS21WIFI-EP	TDS21WIFI-WP	TDS21WIFI-WPB
Thermostat	✓	✓	✓
User Manual	✓	✓	✓
Screws	✓	✓	✓
External sensor	✓		

Our Service:

We offer the warranty of 24 months from the sales day.

During the warranty, if it is belong to the quality issue, we will fix or replace them for you by free after test them.

If it is not quality problem or beyond the warranty time, we will charge for the after-sales service.

7. Switch of Manual mode and Auto mode: Press to switch manual mode or Auto mode.

8. Power off: Press to turn on or off thermostat.

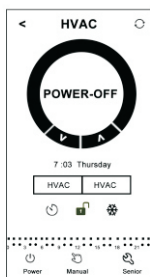

XI. Attention to Phone WiFi Connection:

1. After you press Configure, if connection fails:

a. Please confirm your mobile phone is set to WLAN mode, and ensure its (mobile data)3g/4g is turned off. Please connect to 2.4G wifi, not 5G wifi.

b. Please add your wifi router name, we recommend it does not include spaces or Chinese symbol.

c. Please check your wifi router password. We recommend not over 32 characters, no spaces, no blank password, no special symbols except letters and numbers.

d. Please check module is successfully reset. In power-off state, press Time key firstly, then press Power key to enter Advanced Setting. Find FAC mode, to change FAC to 10 or 32, then turn thermostat off.....

Press Time key within 2 minutes, then press Power key again. This time, it will not enter Advanced Setting, but WIFI symbol on the LCD screen will be flashing quickly and frequently. This means wifi module has been reset successfully. Then wait for APP to connect well.

e. Please confirm wifi password is correctly filled. We recommend you check password to be visible when it is input.

2. If it displays the following reminder, please go to Advanced Setting to reset corresponding setting.

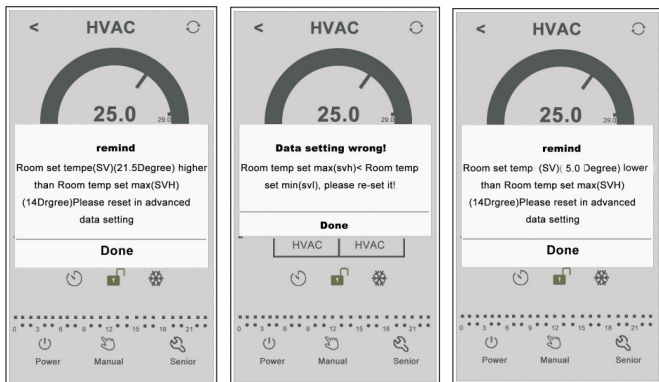

XI. Installation Instruction

This product is suitable for standard 80*80mm wall box and 60 mm european round box.

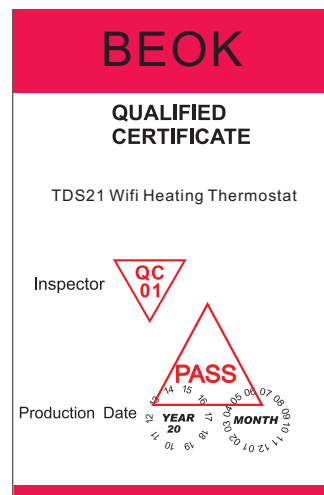

Warning:



The symbol means the unit is being installed, it may cause electrical shock hazard during maintaining, so please make sure it is operated by the professional technical worker.

